

FourReal® 74

EN

Design: Strand + Hvass & Four Design

Table top finishes

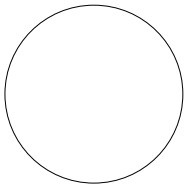

WHITE DECOR
W450

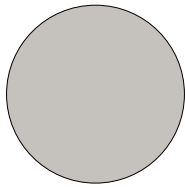

LIGHT GREY EGGER
U763 ST9 DECOR

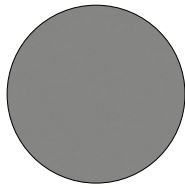

GREY EGGER U732
ST9 DECOR

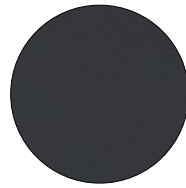

ANTHRACITE ARPA
FENIX 0724

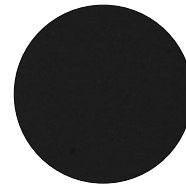

BLACK ARPA FENIX
0720



WARM GREY ARPA
FENIX 0718

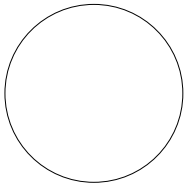

WHITE MDI38
MODEKOR

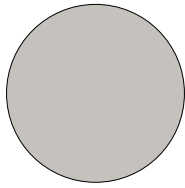

LIGHT GREY EGGER
U763 ST9 LAMINATE

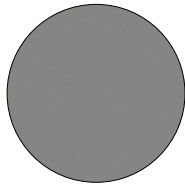

GREY EGGER U732
ST9 LAMINATE

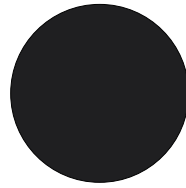

LINOLEUM BLACK

Frame colours

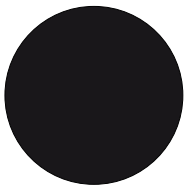

MAT BLACK

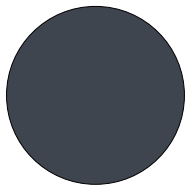

MAT GREY

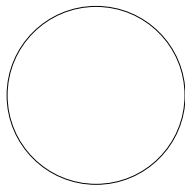

MAT WHITE

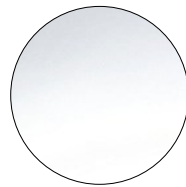

CHROME

Options

Trolley

Chair suspension

Room In Room

Cable duct, aluminium

Linking device

FourReal® 74

EN

Design: Strand + Hvass & Four Design

FourReal 74 - 120 x 80

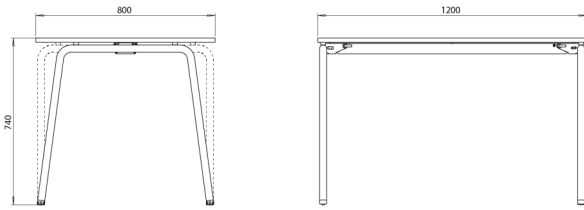

FourReal 74 - 128 x 64

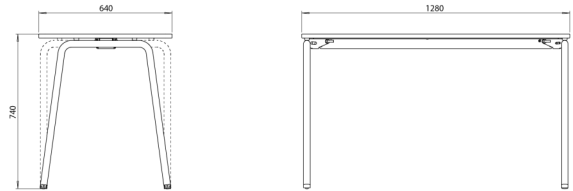

FourReal 74 - 140 x 70

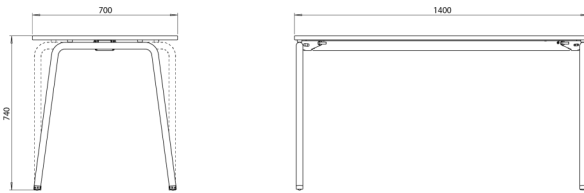

FourReal 74 - 140 x 80

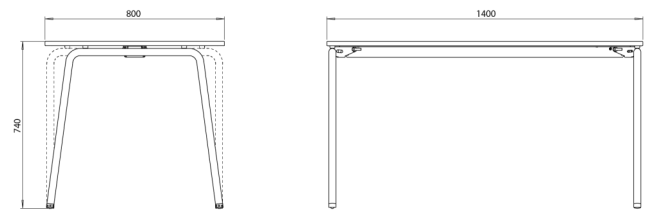

FourReal 74 - 160 x 80

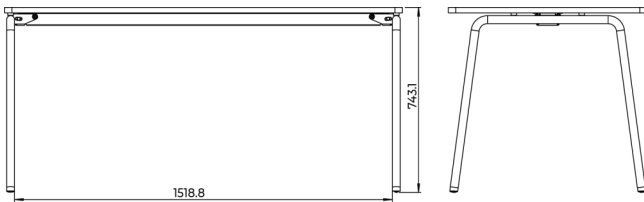

FourReal 74 - 180 x 80 Curved

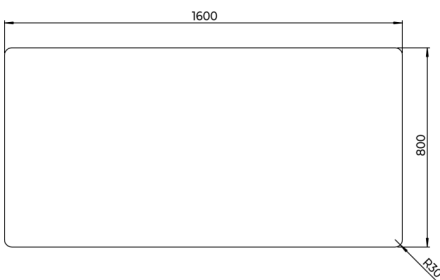
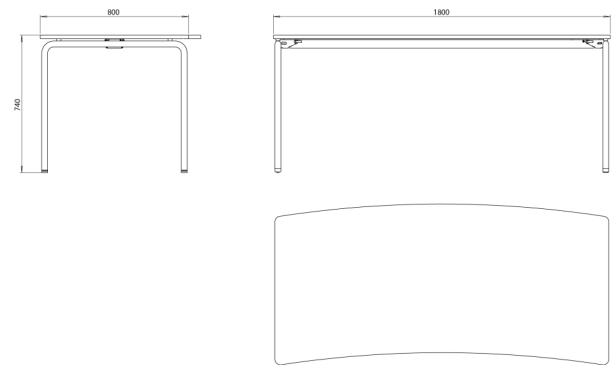

FourReal[®] 74

EN

Design: Strand + Hvass & Four Design

FourReal 74 - 180 x 80

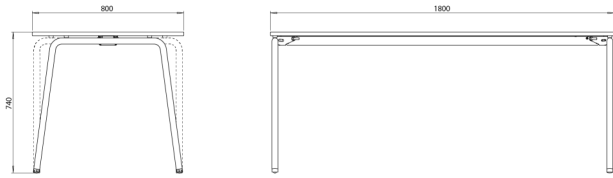

FourReal 74 - 80 x 80

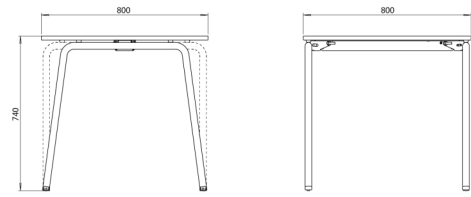

FourReal 74 - Ø120

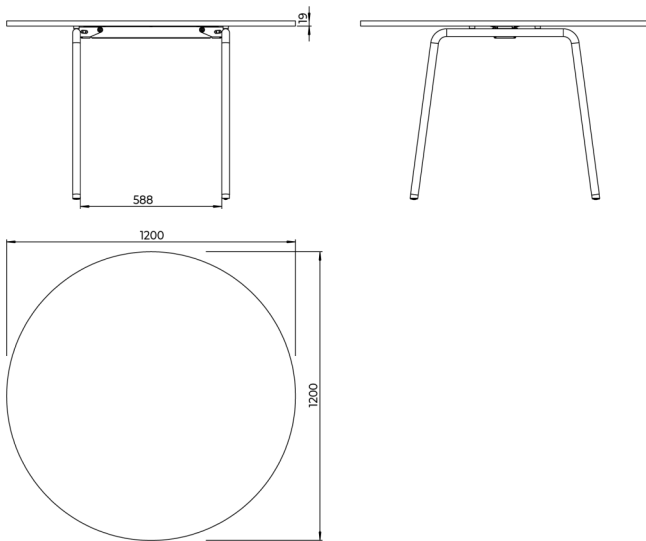

Design: Strand + Hvass & Four Design

Materials

Table top variants

Chip board with Decor laminate and ABS-edge.
Thickness: 19 mm

Chip board with high-pressure laminate or Fenix laminate and ABS edge.
Thickness 19 mm

MDF board with linoleum and linoleum edges.
Thickness 23 mm

Frame

Legs: $\varnothing 32 \times 2.5$ mm, S235 steel, EN 10305-3 F300C
Rail: Aluminium EN AW-6063 T
Folding mechanism: Domex 240 – FE 360 D2 steel
2 integrated castors: LDPE
2 height adjustment glides: LDPE (not on slanted legs)
Rubber cushions: EPDM Rubber
Spacer blocks: LDPE
Cable duct: Aluminium

Instructions

Assembly instructions can be found at www.four.design under FourReal 74.

Weight and dimensions

80x80 cm: 18,1 kg
120x80 cm: 23,6 kg
128x64 cm: 21,4 kg
140x70 cm: 25,1 kg
140x80 cm: 27 kg
180x80 cm: 33,5 kg
180x80 cm (curved): 33,5 kg

Quality and Environment

At Four Design, we are aware of our environmental responsibility. We strive to reduce our company, and our customer's impact on the environment by producing quality furniture in a sustainable manner.

Procurement

We procure materials from responsible suppliers who comply with our high standards, ensuring that the materials are sustainably sourced and managed, conforming to applicable laws and regulations such as legal logging and chemical restrictions.

Production

We are ISO14001 certified, guaranteeing excellent environmental standards of our manufacturing sites.

Use

Four Design provides a 5-year warranty on all products within our price list. This warranty covers breakage and damage of products occurring because of deficient craftsmanship performance under normal use. The warranty shall lapse if the product shows signs of mishandling abuse or other physical damage. The warranty does not cover those parts of the product which are exposed to abrasion during use.

We kindly refer to our Maintenance Guide: http://www.fourdesign.dk/pdf/Maintenance_Guide.pdf

Recycling

We are working towards the aim for all our products to be minimum 95% recyclable. Products must be separated into their components and disposed of separately. All metal parts can be disposed of and recycled by an approved organisation. Lacquered frames are treated with a paint classified as not dangerous according to directive 1999/45/EF. Wood can either be recycled or incinerated. Plastic shells can be recycled. The shell will be granulated and reused in new plastic production. Upholstery and veneer shells are not recyclable but can be disposed of by incineration.