

FourSure® 77

EN

Design: Strand + Hvass

Shell colour

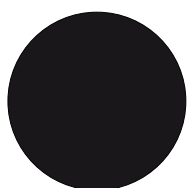

EBONY BLACK

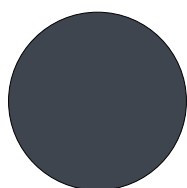

ANTHRACITE

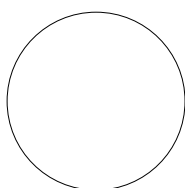

SNOW

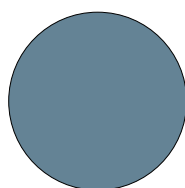

AQUA

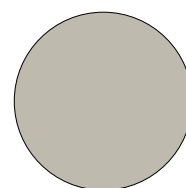

BEACH

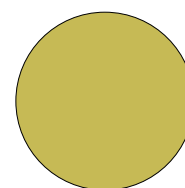

OLIVE

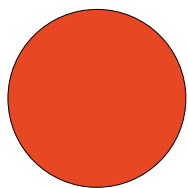

ORANGE

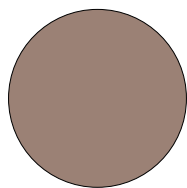

TERRACOTTA

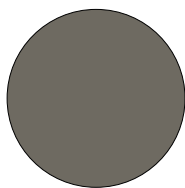

CLAY

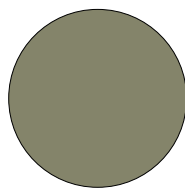

MOSS

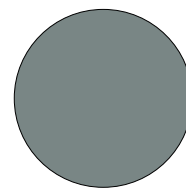

PINE

Frame colour

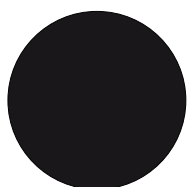

MAT BLACK

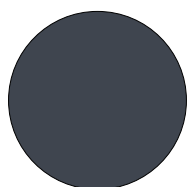

MAT GREY

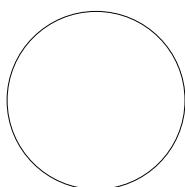

MAT WHITE

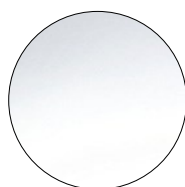

CHROME

Options

Upholstery: Seat upholstery / inside upholstery / fully upholstered

Armrest / Loop

Grip hole

FourSure® 77

EN

Design: Strand + Hvas

FourSure 77 - plastic shell - With armrest

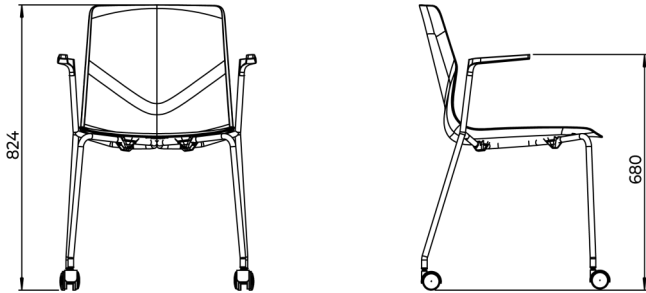

FourSure 77 - plastic shell

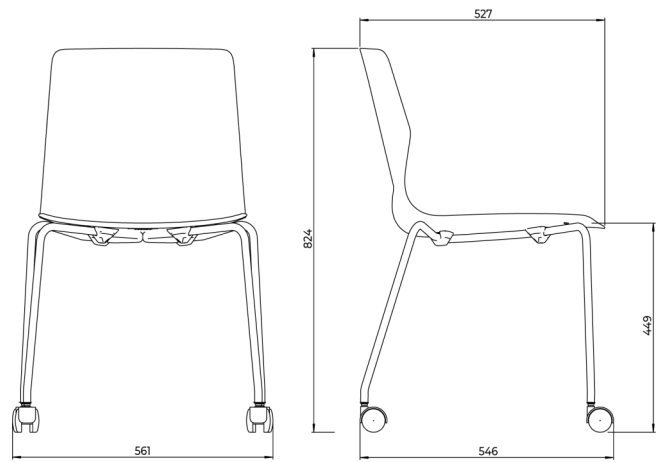

Design: Strand + Hvass

Materials

Shell

Polyshell: PP, reinforced glass fibre (Skin: 15%, core: 40%), recyclable.

Meets the REACH directives and are halogen free.

Black shells are made of 100% recycled material.

Glue veneer: Gasco Adhesive 1272.

Foam: Type CMHR-65H eco-tex standard 100. Complies with the REACH and RoHS directives. Fire retardant.

Glue Foam: SABA Activator 3739, Aquabond RSD 3801 blue.

Foam thickness:

Seat upholstery: 15 mm.

Inside upholstered: 15 mm.

Fully upholstered: 20/10/5 mm.

Frame, Steel

Tube: Ø16 X 2 mm, Ducol 500

Glides (standard): PA

Lock: ABS/Pa6

Upholstery protector: ABS

Weight and dimensions

Weight: 6,2 kg

Quality and environment

At Four Design, we are aware of our environmental responsibility.

We strive to reduce our company, and our customer's impact on the environment by producing quality furniture in a sustainable manner.

Procurement

We procure materials from responsible suppliers who comply with our high standards, ensuring that the materials are sustainably sourced and managed, conforming to applicable laws and regulations such as legal logging and chemical restrictions.

Production

We are ISO14001 certified, guaranteeing excellent environmental standards of our manufacturing sites.

Use

Four Design provides a 5-year warranty on all products within our price list. This warranty covers breakage and damage of products occurring because of deficient craftsmanship performance under normal use. The warranty shall lapse if the product shows signs of mishandling abuse or other physical damage. The warranty does not cover those parts of the product which are exposed to abrasion during use.

We kindly refer to our Maintenance Guide: http://www.fourdesign.dk/pdf/Maintenance_Guide.pdf

Recycling

We are working towards the aim for all our products to be minimum 95% recyclable.

Products must be separated into their components and disposed of separately.

All metal parts can be disposed of and recycled by an approved organisation. Lacquered frames are treated with a paint classified as not dangerous according to directive 1999/45/EF.

Wood can either be recycled or incinerated.

Plastic shells can be recycled. The shell will be granulated and reused in new plastic production.

Upholstery and veneer shells are not recyclable but can be disposed of by incineration.